

GAMA

by
bürotime

document technique



GAMA



“Les approches pédagogiques évoluent avec les technologies en développement constant. Ces changements créent des opportunités pour de nouvelles méthodes d’enseignement et accélèrent les modulations vers des environnements actifs d’enseignement, focalisés sur les élèves/étudiants. Les designs Bürotime ne limitent pas l’enseignement aux zones considérées comme classiques et prédéfinies. Au contraire, ils construisent de nouvelles approches de pédagogie active. Bürotime propose des solutions efficaces qui transformeront petit à petit chaque parcelle d’un établissement d’enseignement en lieu d’apprentissage.”



La ligne Gama, qui incarne l'endurance et le confort, offre des solutions ergonomiques destinées aux espaces d'enseignement. Ses alternatives de hauteur permettent aux différents groupes d'âge de se sentir en confiance. Ses options de rangs simple et double autorisent de multiples scénarios d'utilisation.





L'étagère fixe sous le bureau et le porte-sac au pied de la table organisent l'espace de travail et renforcent le sentiment d'appartenance à l'égard du lieu d'enseignement. Les accessoires comme le porte-crayon et le porte-tablette permettent une utilisation aisée des dispositifs technologiques et permettent à chacun de participer activement aux formes d'apprentissage proposées.

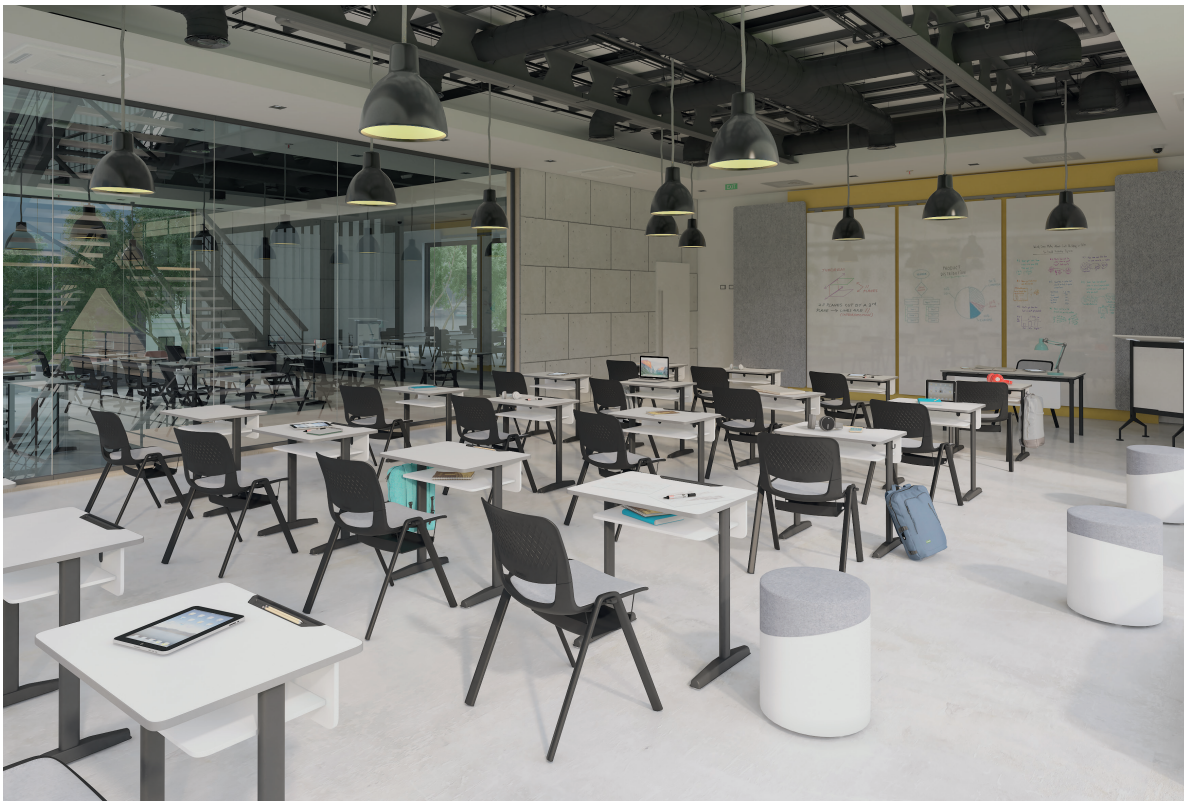

famille de produits _____



rang simple



rang double

caractéristiques de la table _____

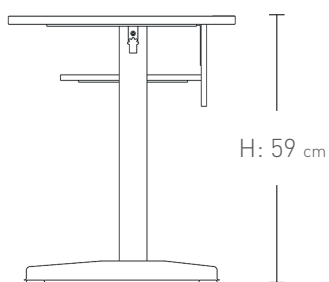
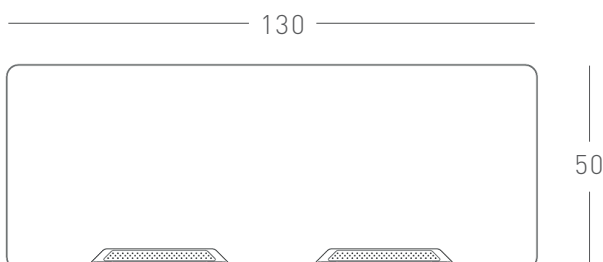
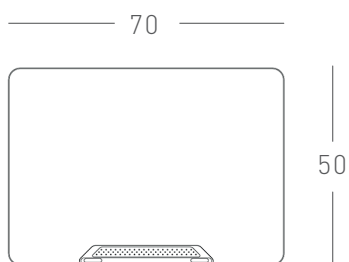

petite
6-8 ans

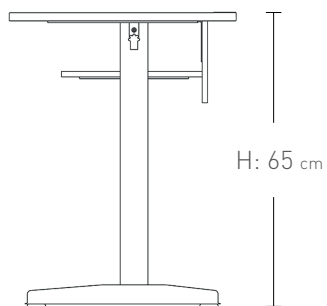

moyen
8-11 ans

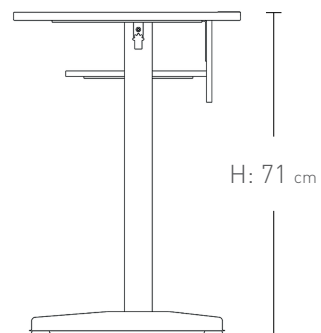

grand
11-14 ans



options de couleur mélamine

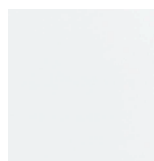

blanc

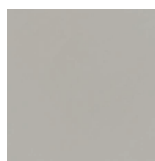

sable

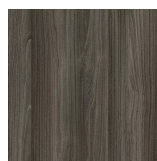

chêne fumé

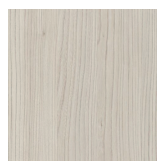

chalef

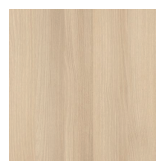

acacia

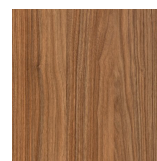

noyer samba

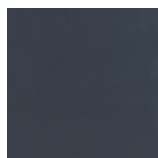

anthracite

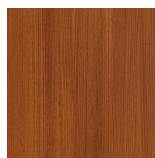

noisette

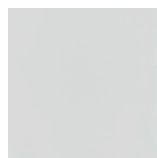

gris

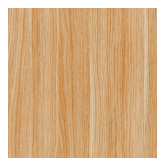

chêne naturel

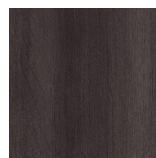

chêne africain

métal

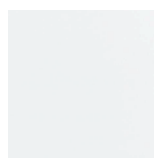

blanc

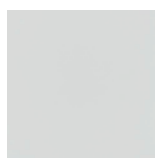

gris

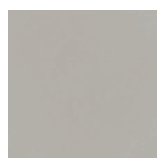

sable

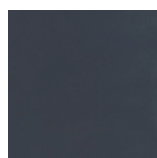

anthracite



noir